



















<b>B1</b>		φ 8x28	x27
<b>T1</b>			x27
<b>M1</b>			x27
<b>C2</b>		φ 20	x20
<b>C2</b>		φ 20	x12
<b>W1</b>			x8
<b>W2</b>			x8
<b>F1</b>			x14
<b>P2</b>		3x16	x28
<b>G4</b>			x12
<b>J23</b>			x10
<b>F15</b>			x6

<b>X5</b>		x6
<b>S9</b>		4x16 x12
<b>D2</b>		x6
<b>X19</b>		x2

<b>L21</b>		x5
<b>P13</b>		3.5x13 x22
<b>J11</b>		x1



Nr	Ausmaß		St	Colli
	480	320		
1	480	320	5	2
2	982	451	4	1
3	1256	383	15	1
4	1256	383	15	1
5	810	80	15	1
6	340	80	15	1
7	340	80	15	2
9	324	160	15	1
10	1256	360	15	2
11	332	345	15	2
12	481	355	15	2
13	332	345	15	2
14	434	60	15	1
15	860	384	15	2
16	860	384	15	2
19	1282	360	18	1
20	1282	494	18	1
23	495	164	2	2
24	1270	346	2	1
25	495	941	2	1

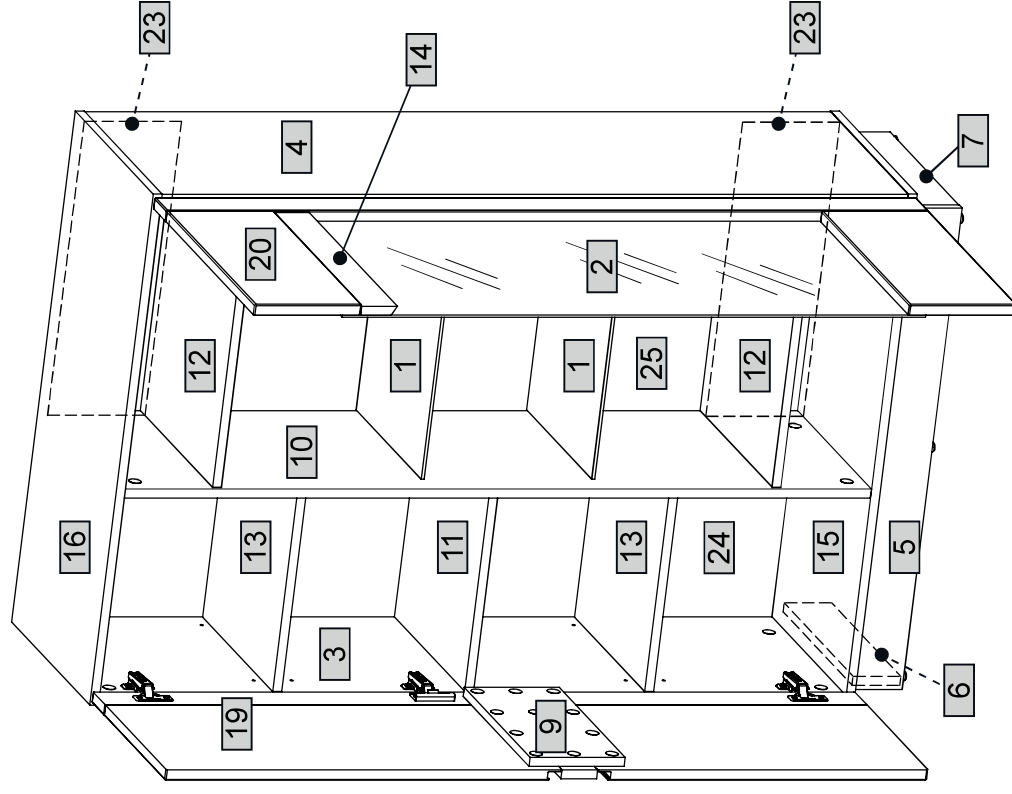

0 10 20 30 40 50 60 70 80 90 100 110 120 130 140 150 160 170 180 190 200

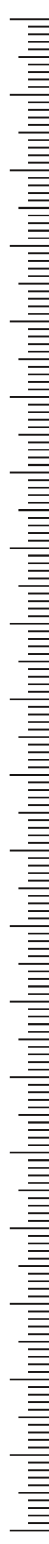

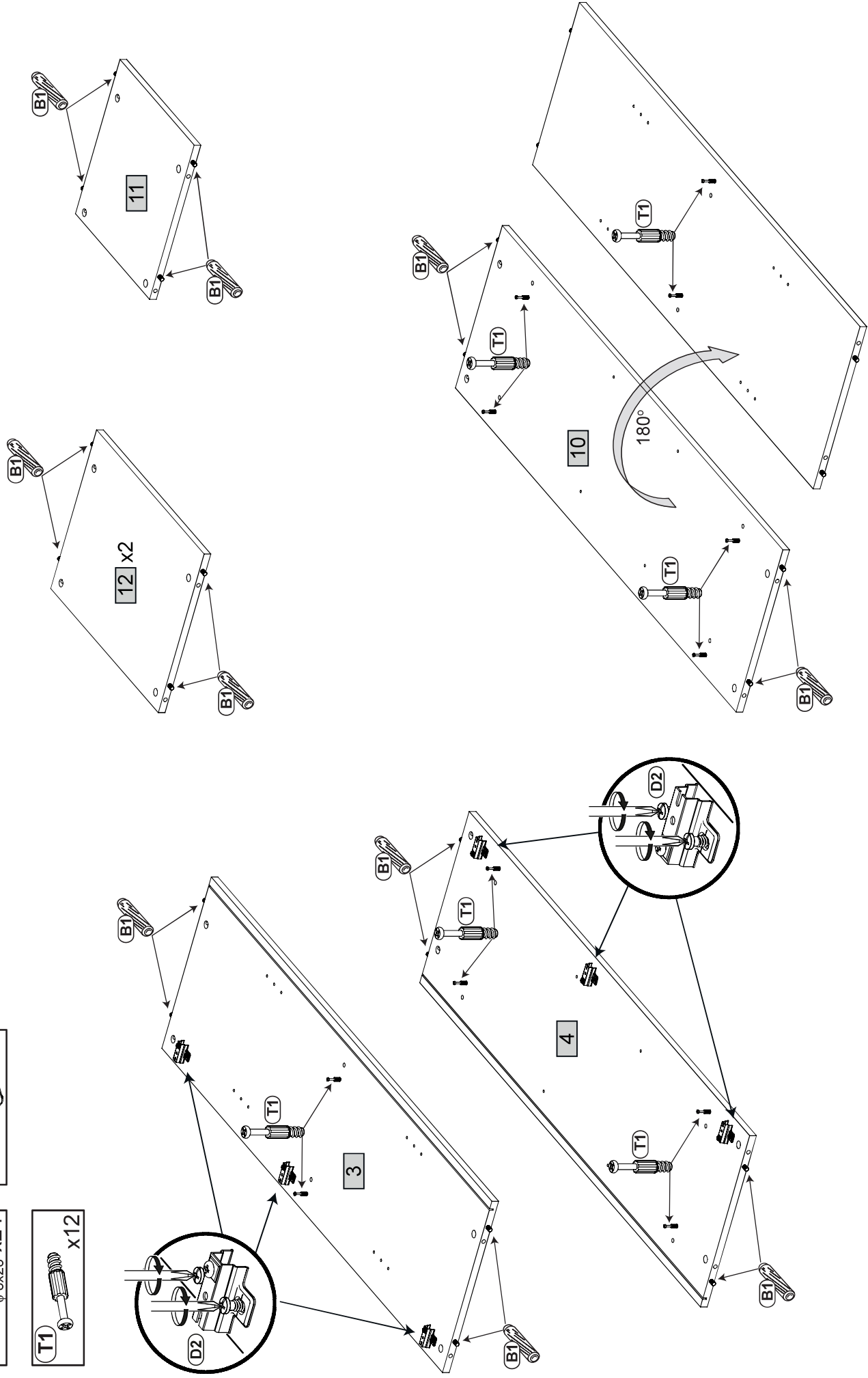
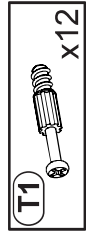
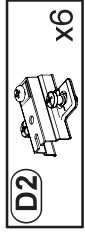
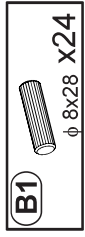

**1**



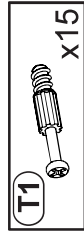
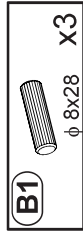

2



3

	x6
	4x16 x12

	x12
	3x16 x12

	$\phi 20$ x12
---	---------------

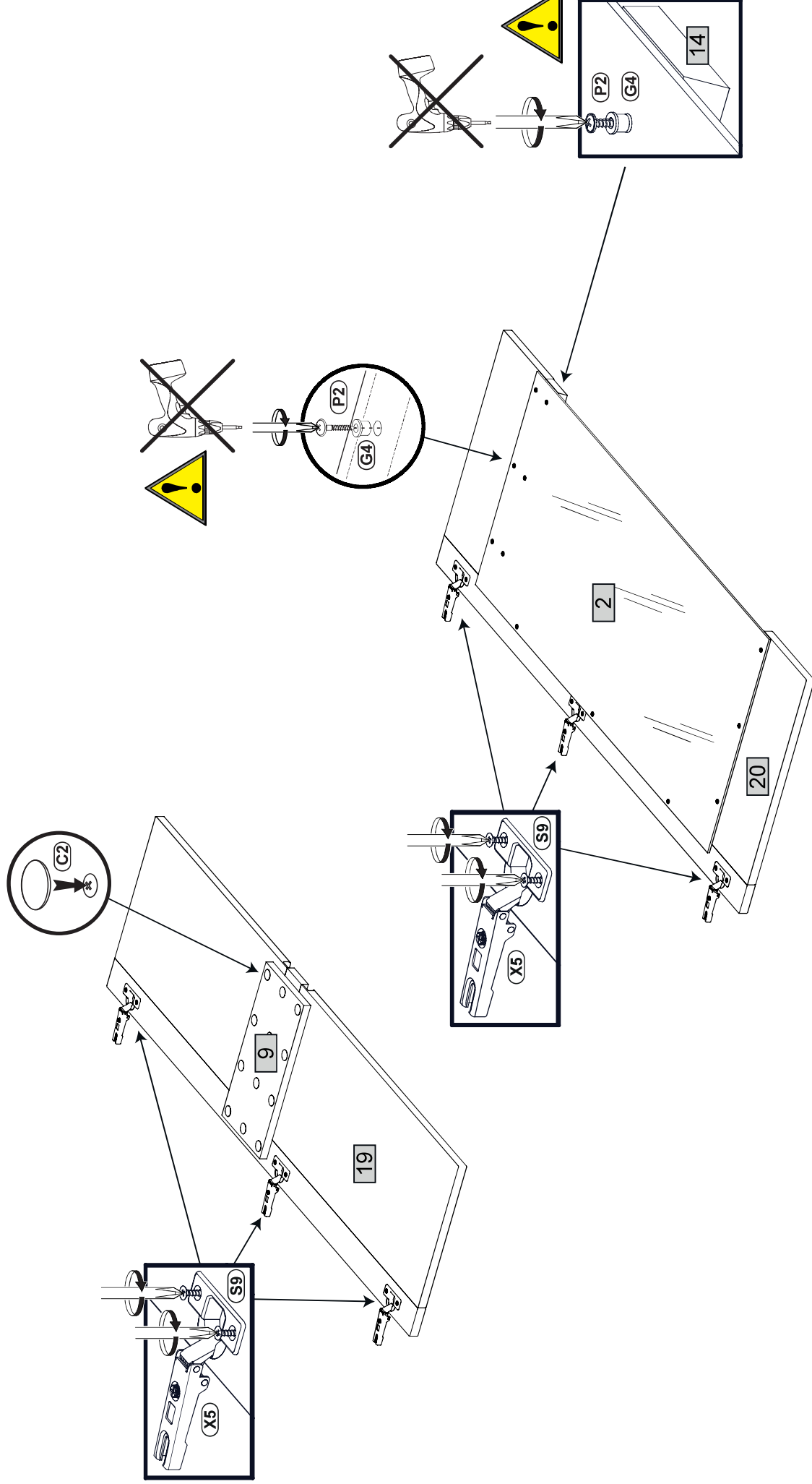

4

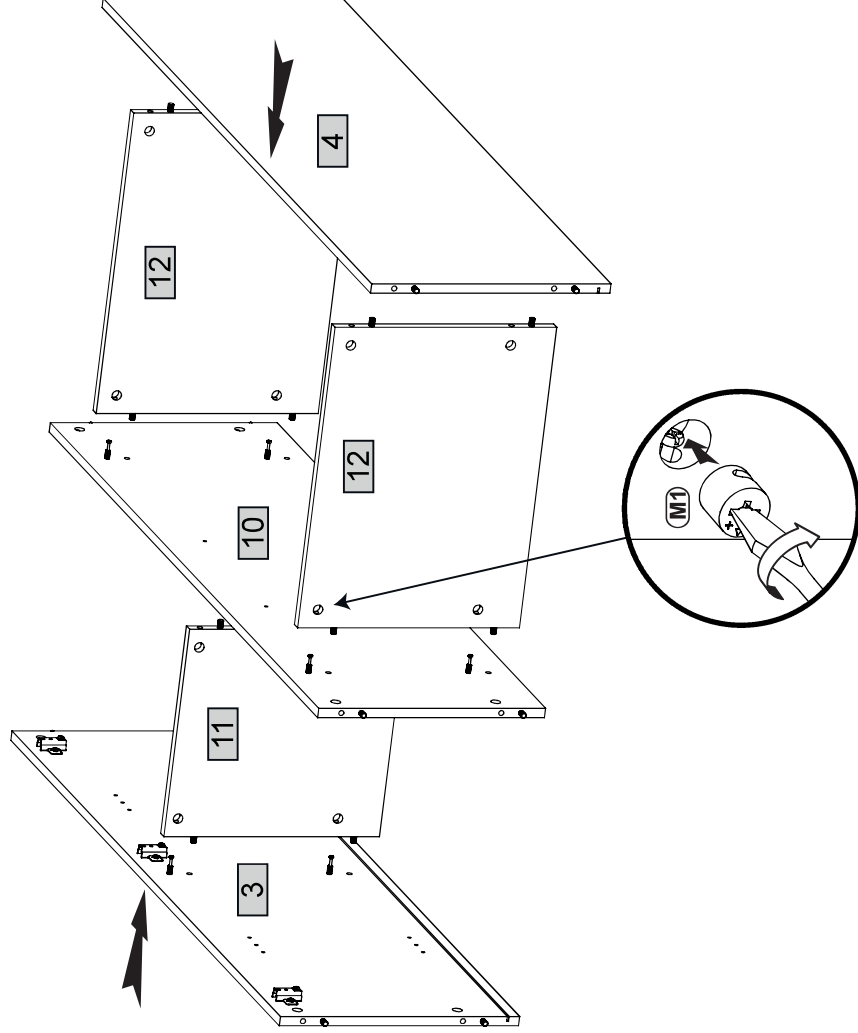

5

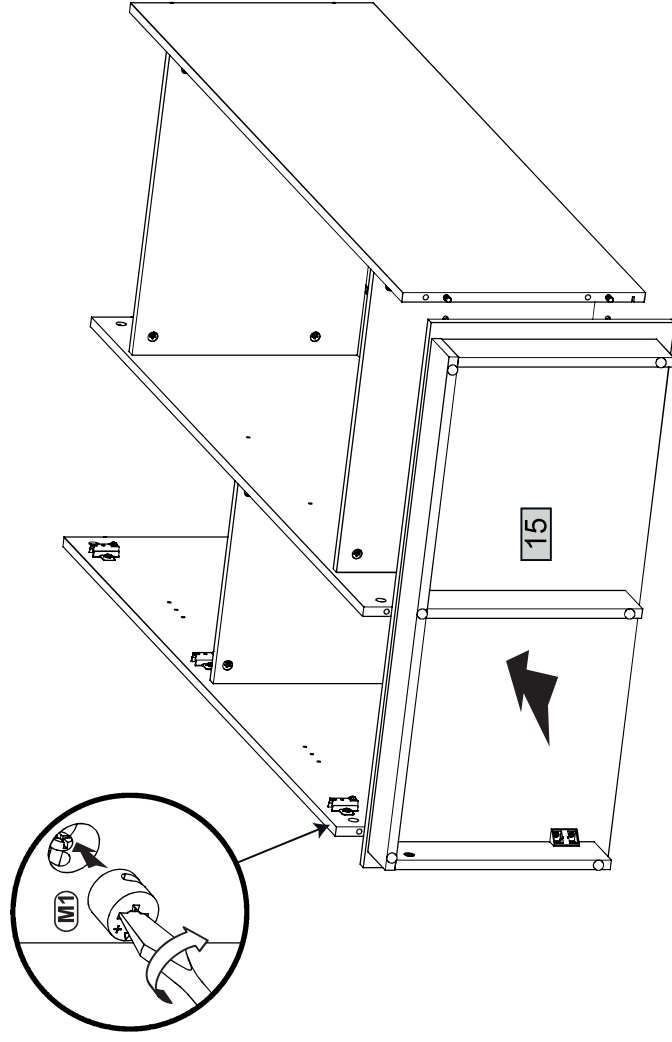

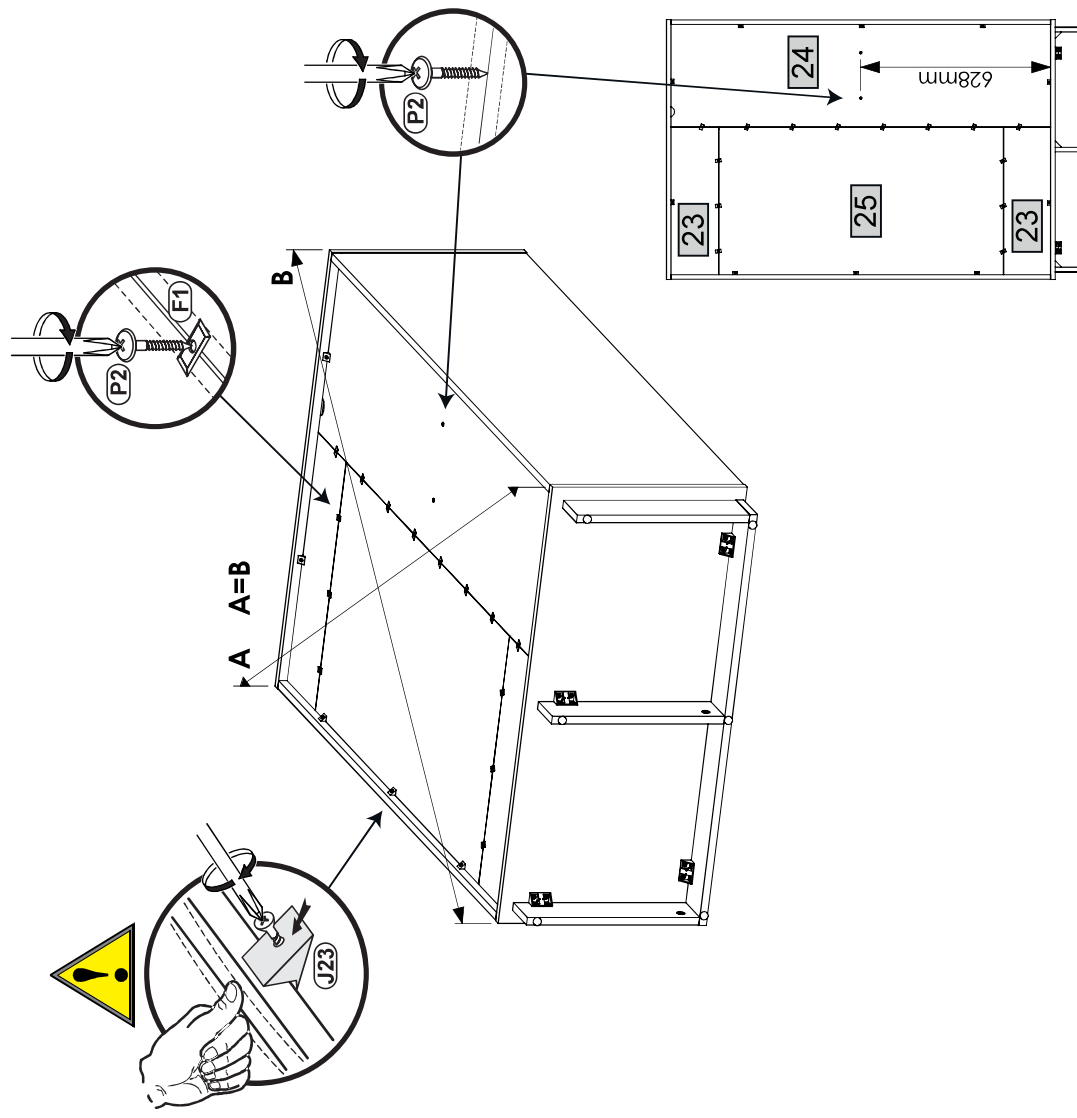
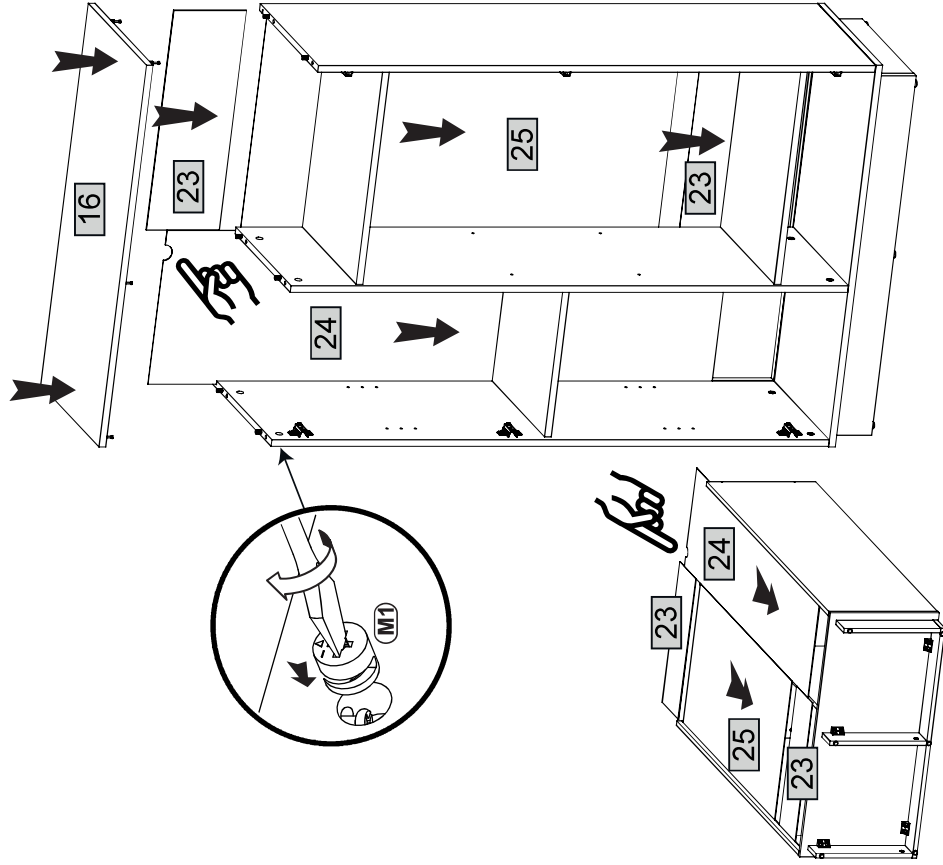

8

- C2**  $\phi$  20 x20 x1
- W1** x8
- W2** x8
- X19** x2

- J11** x1
- P13** 3.5x13 x2

