

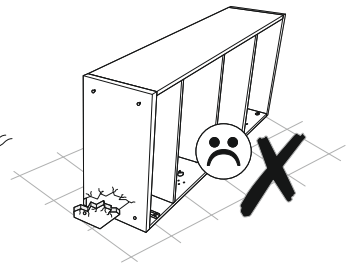

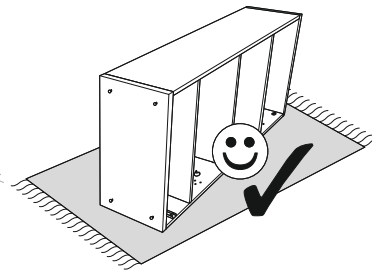

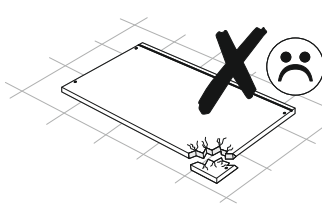

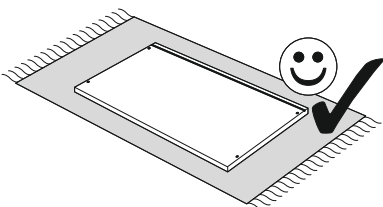
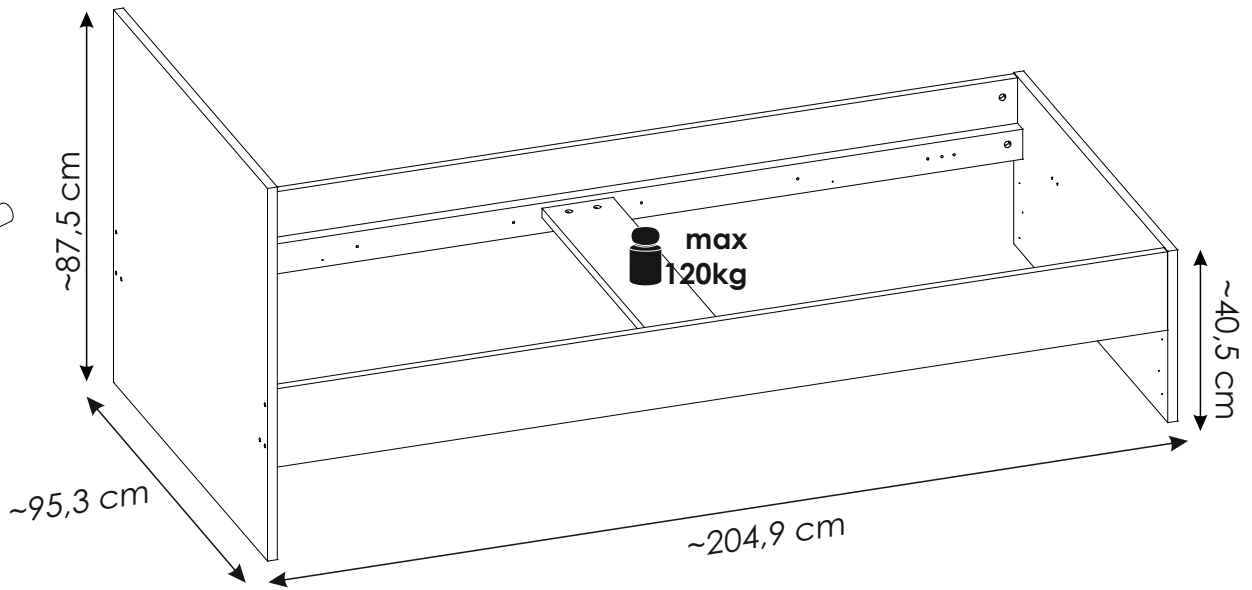
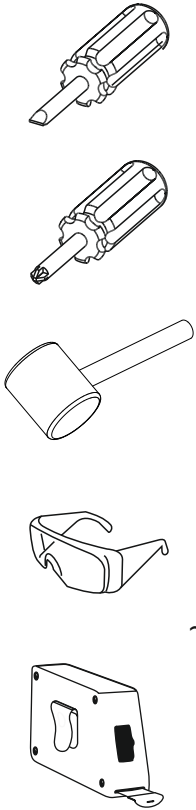
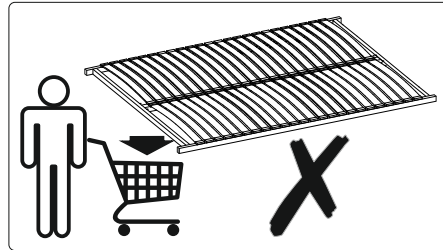
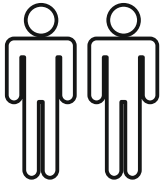
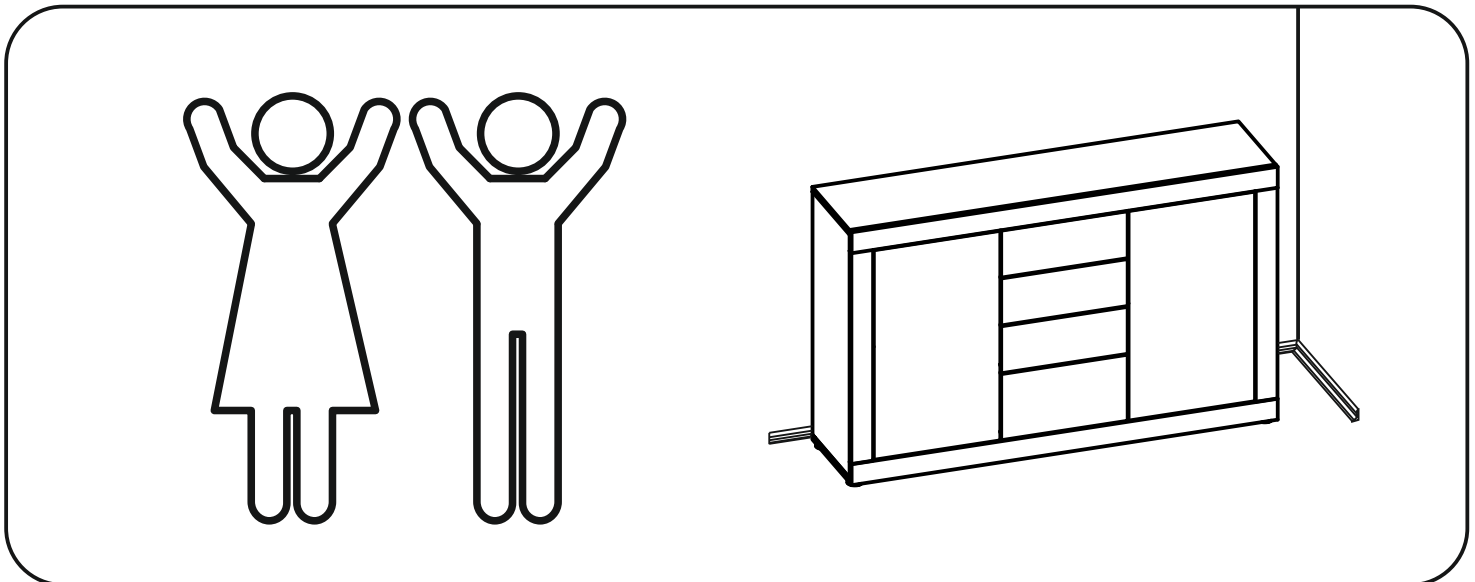
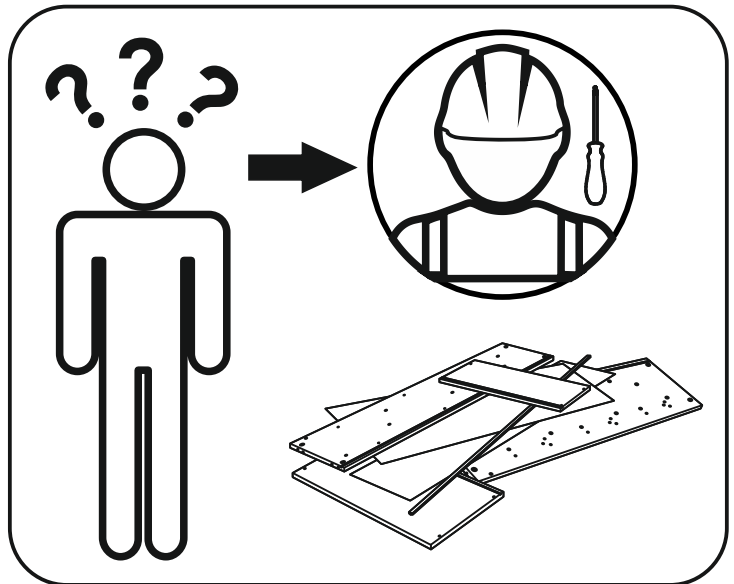
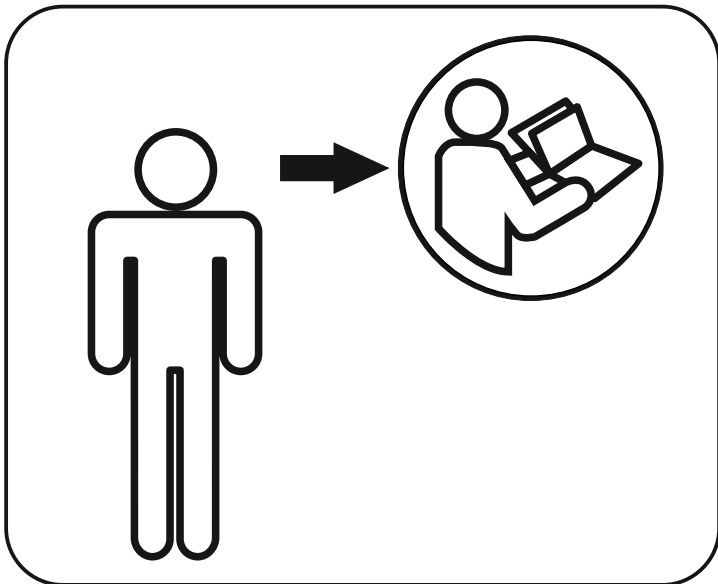
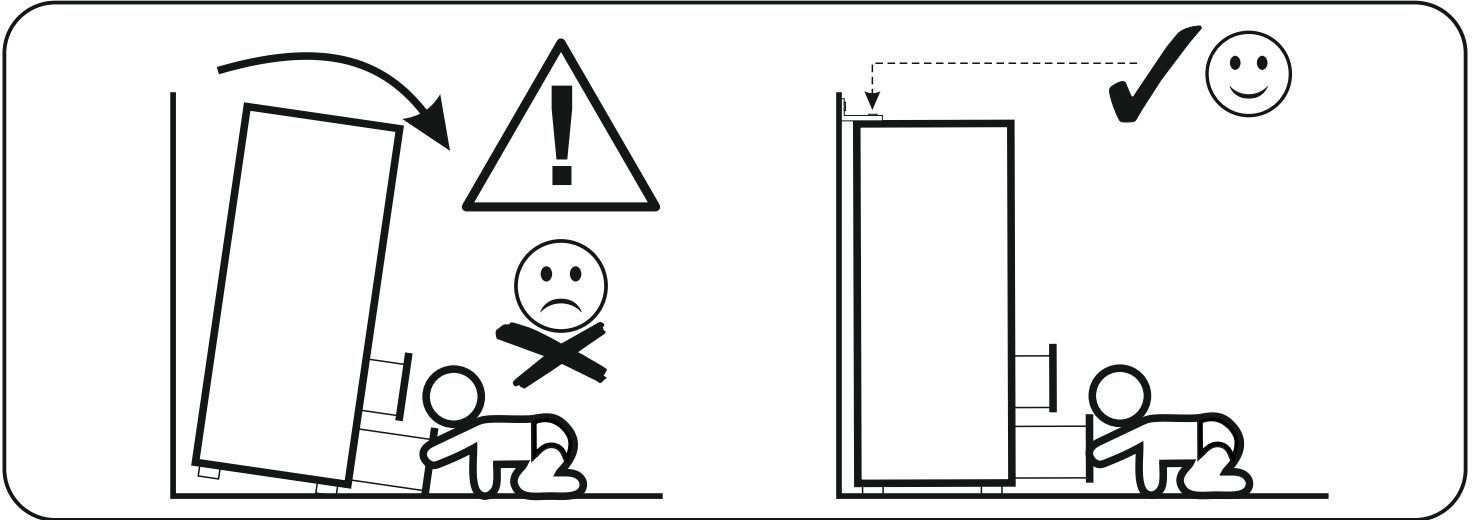
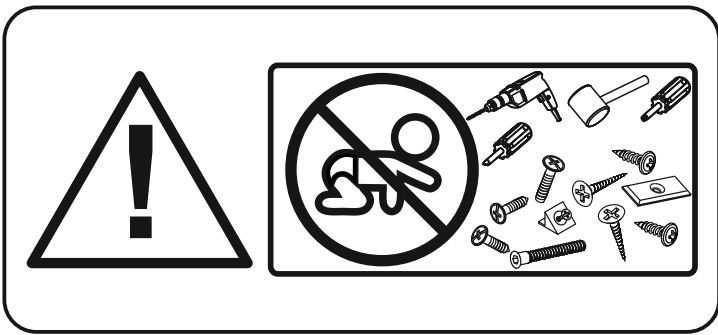

# MRLZ01



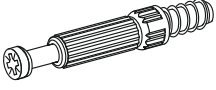

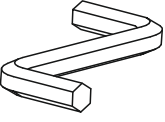
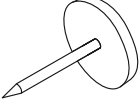
# MRLZ01

<b>A1</b> 8 x 35 mm x28 	<b>C6</b> 6,3 x 16 mm x16 	<b>E1</b> 15 x 12 mm x8 
<b>F1</b> 6 x 34 mm x8 	<b>G1</b> 7 x 50 mm x6 	<b>I19</b> 4 x 50 mm x12 
<b>M</b> x1 	<b>O2</b> x6 	<b>W1</b> x4 

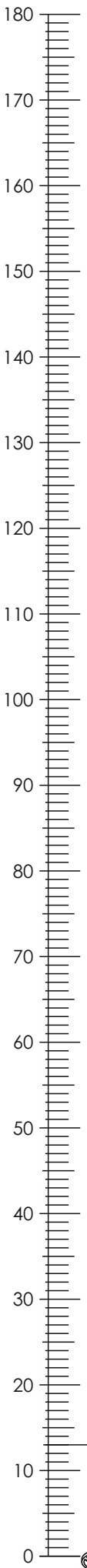

# MRLZ01

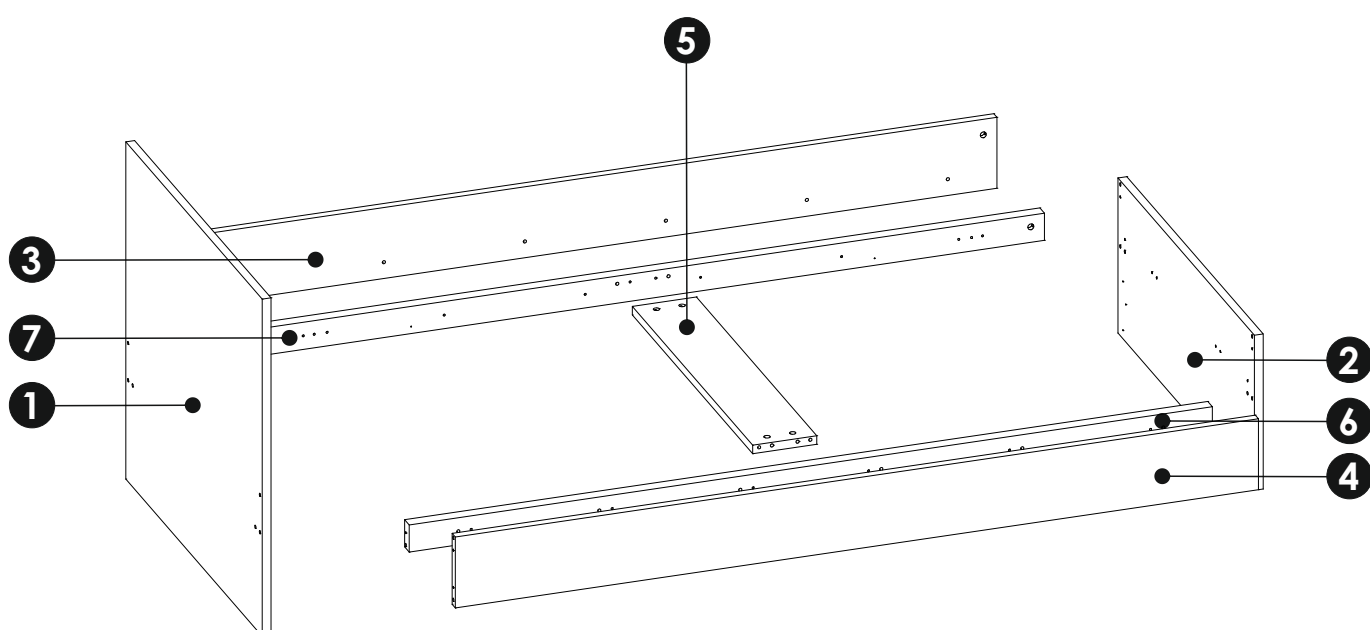
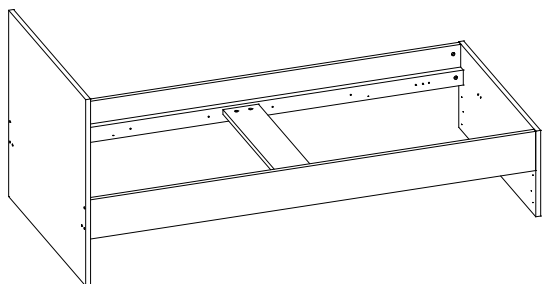

<b>1</b>	953	870	22	x1	1/2
<b>2</b>	953	400	22	x1	1/2
<b>3</b>	2005	183	22	x1	2/2
<b>4</b>	2005	183	22	x1	2/2
<b>5</b>	841	160	22	x1	1/2
<b>6</b>	2005	70	32	x1	2/2
<b>7</b>	2005	70	32	x1	2/2

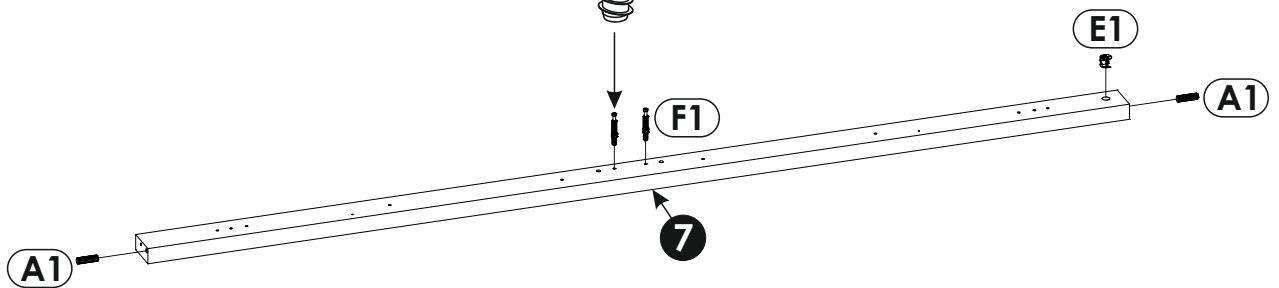
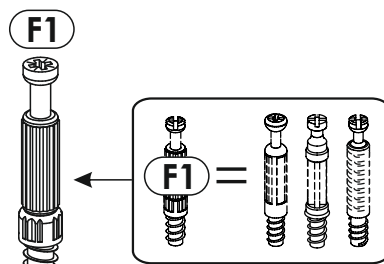
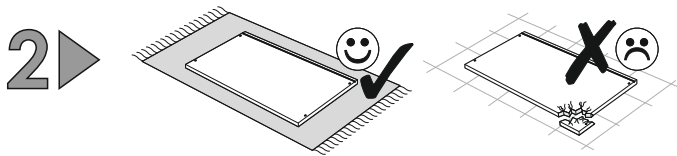
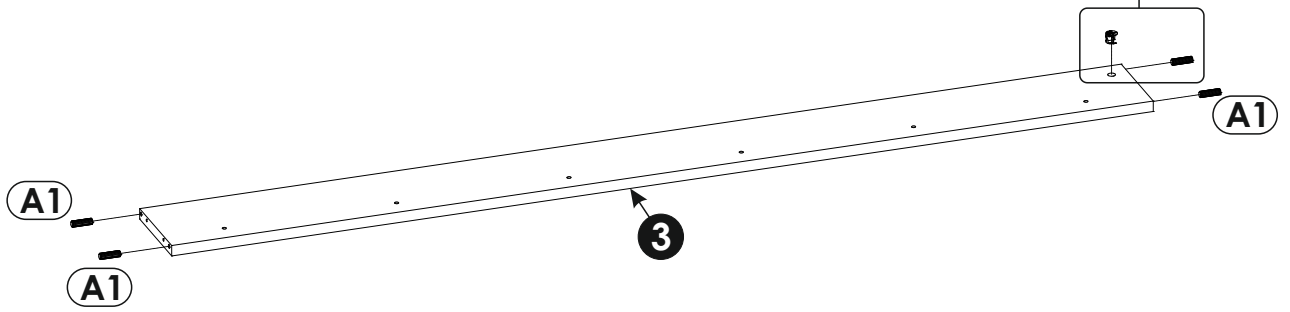
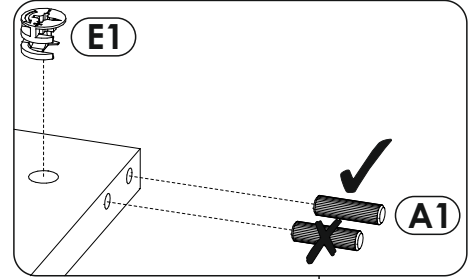
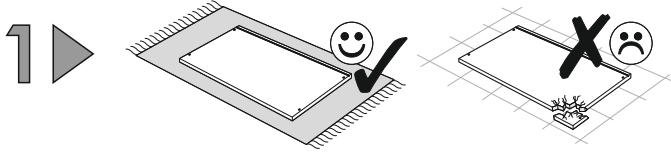

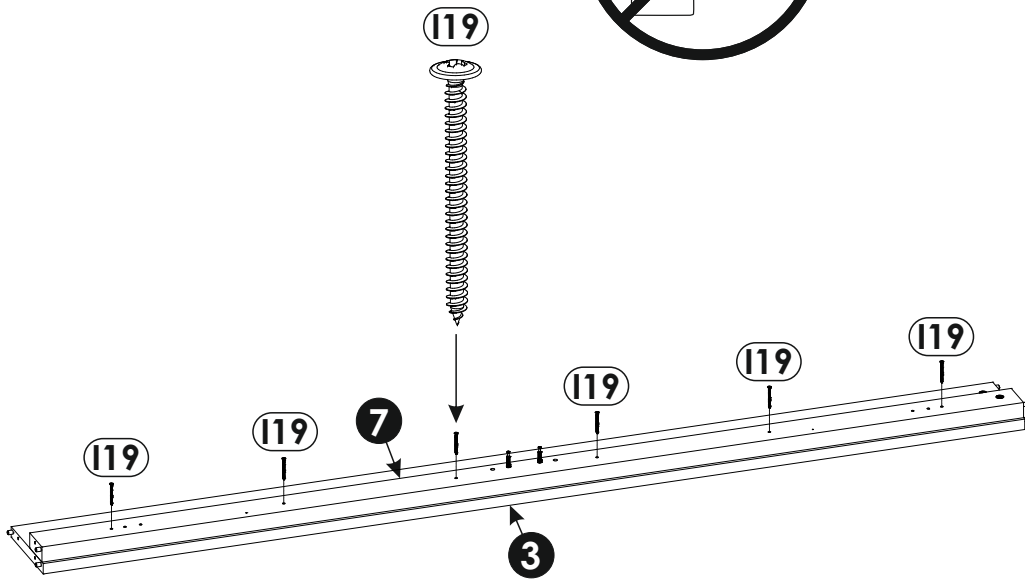
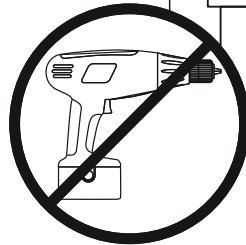
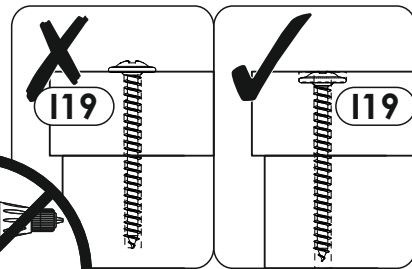
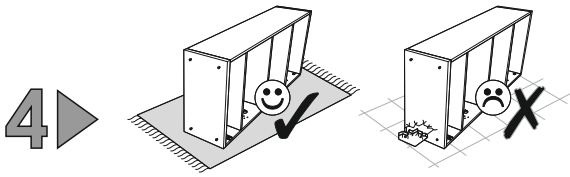
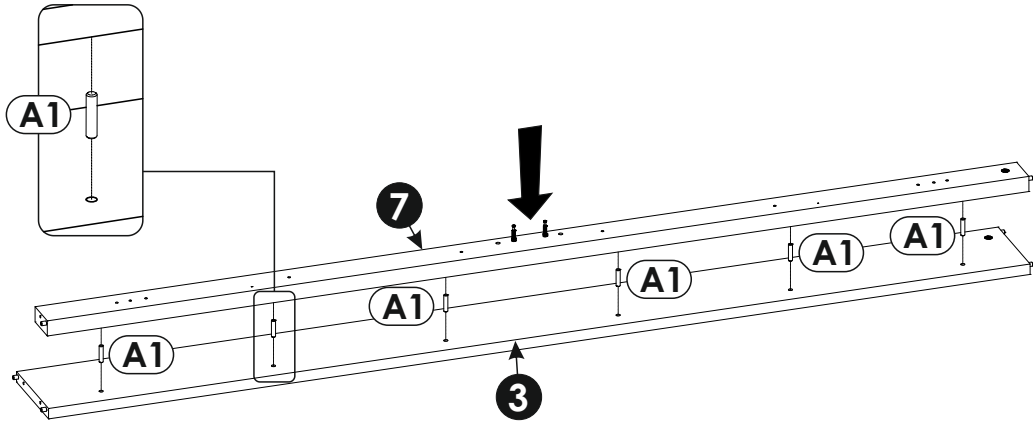
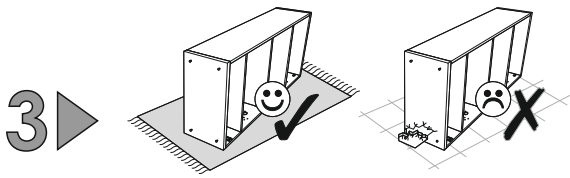

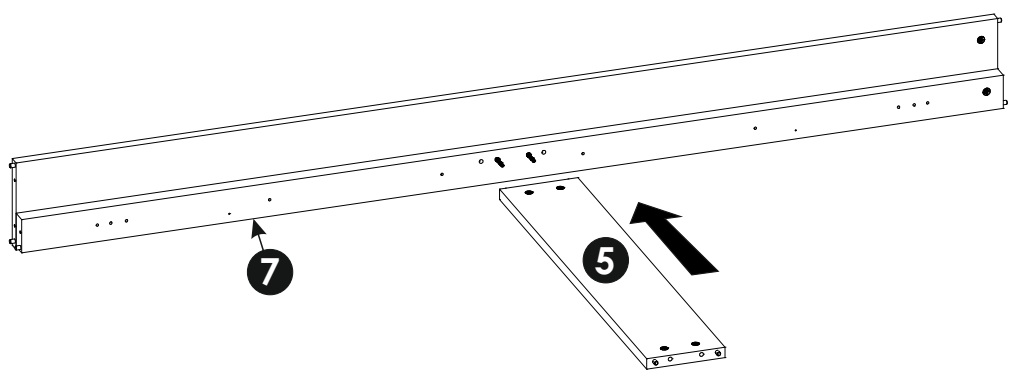
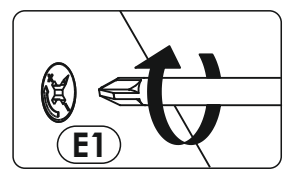
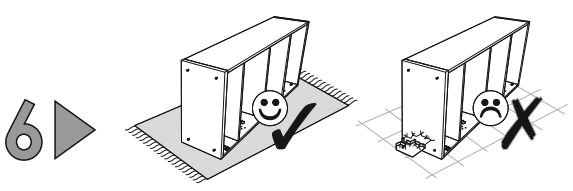
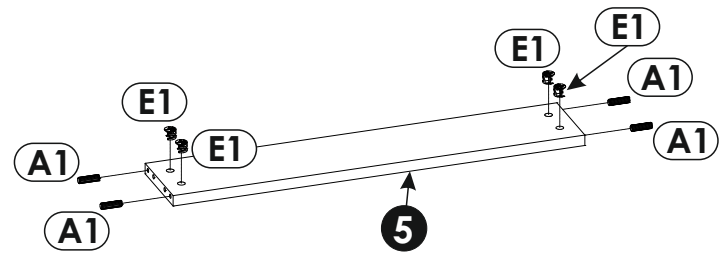
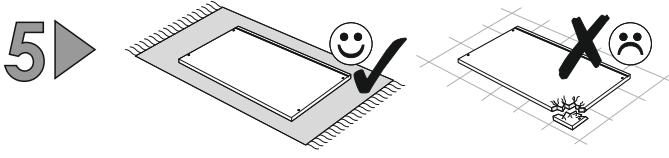

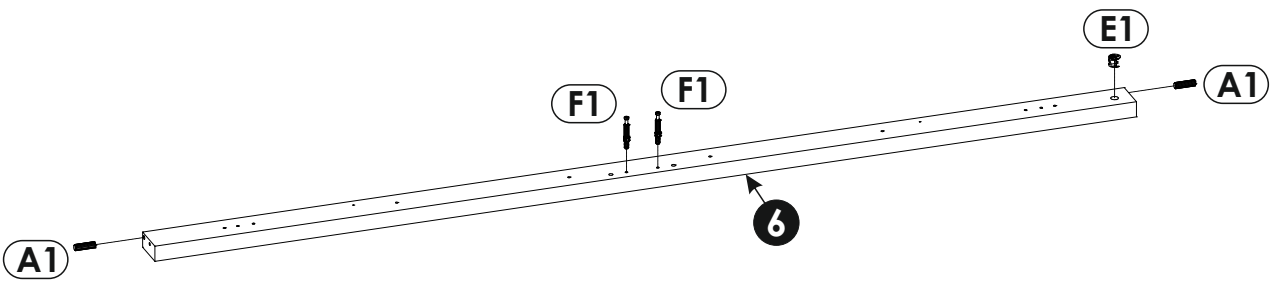
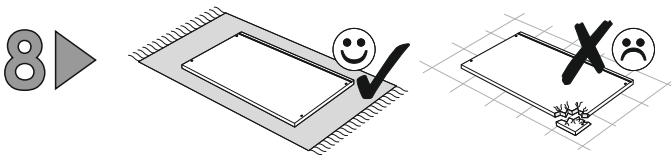
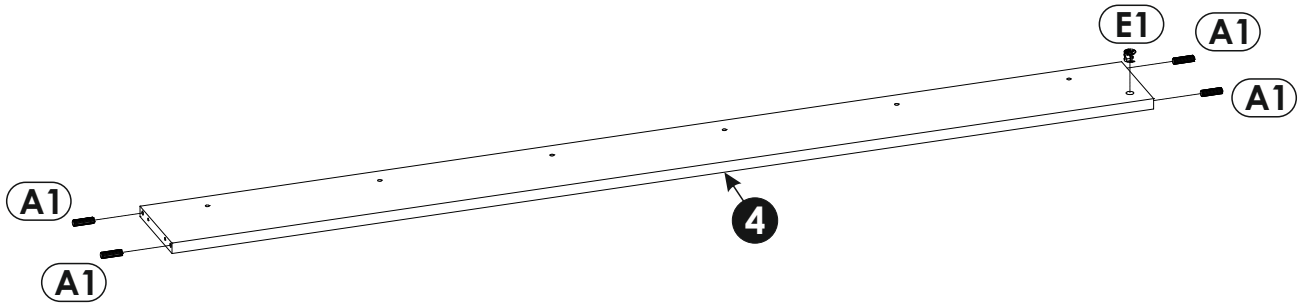
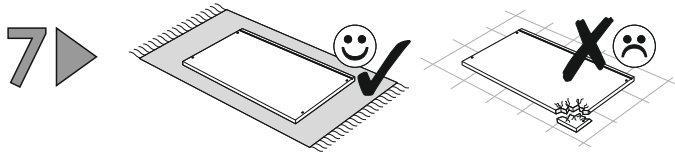



9 ▶

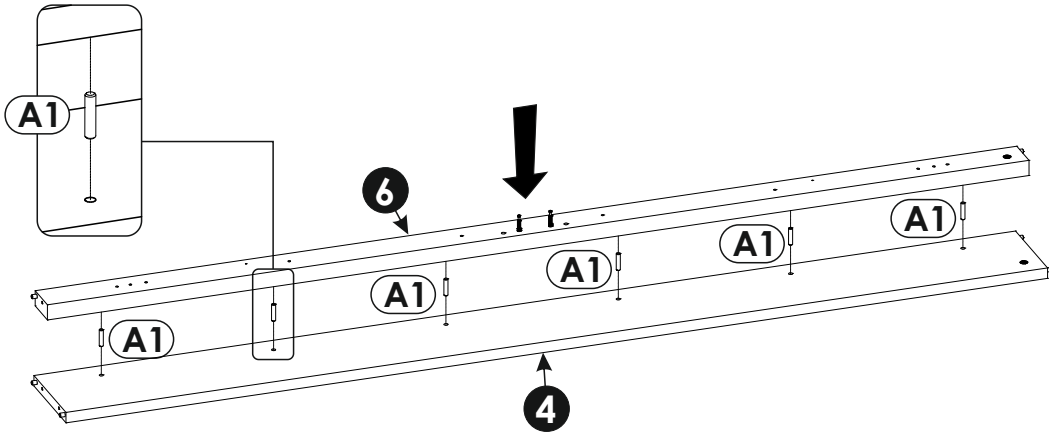
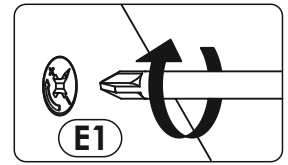
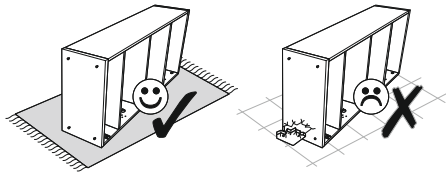

10 ▶

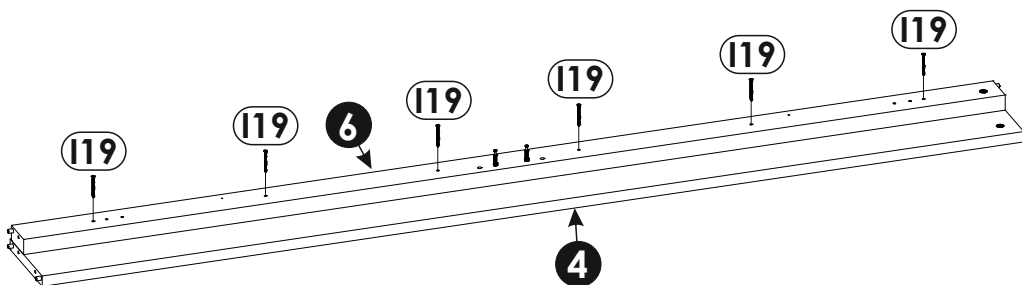
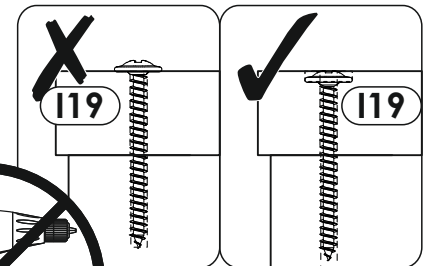
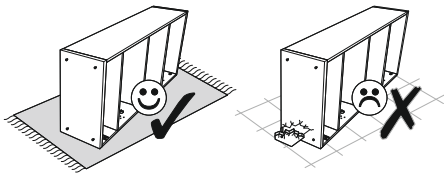

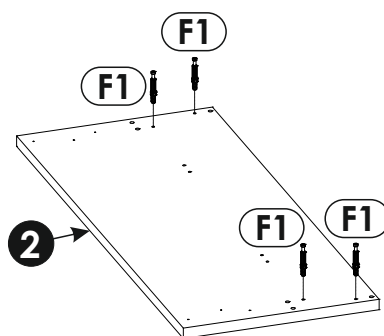
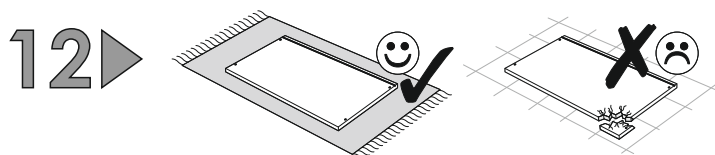
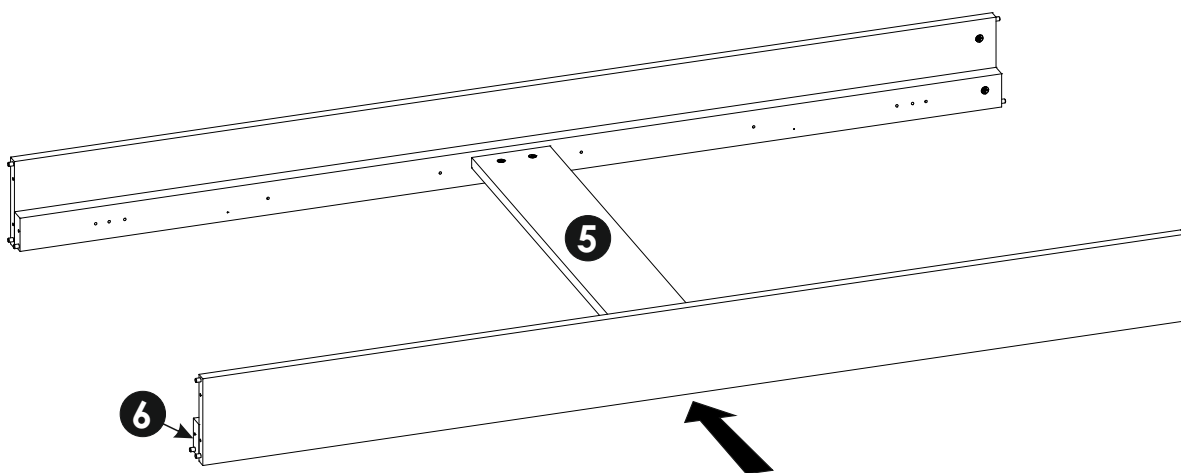
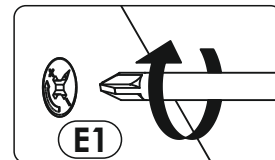
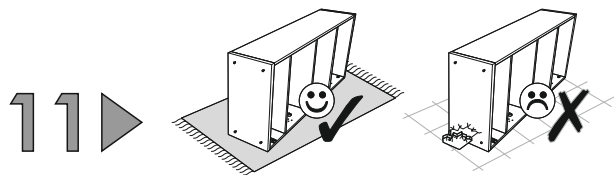

13 ▶

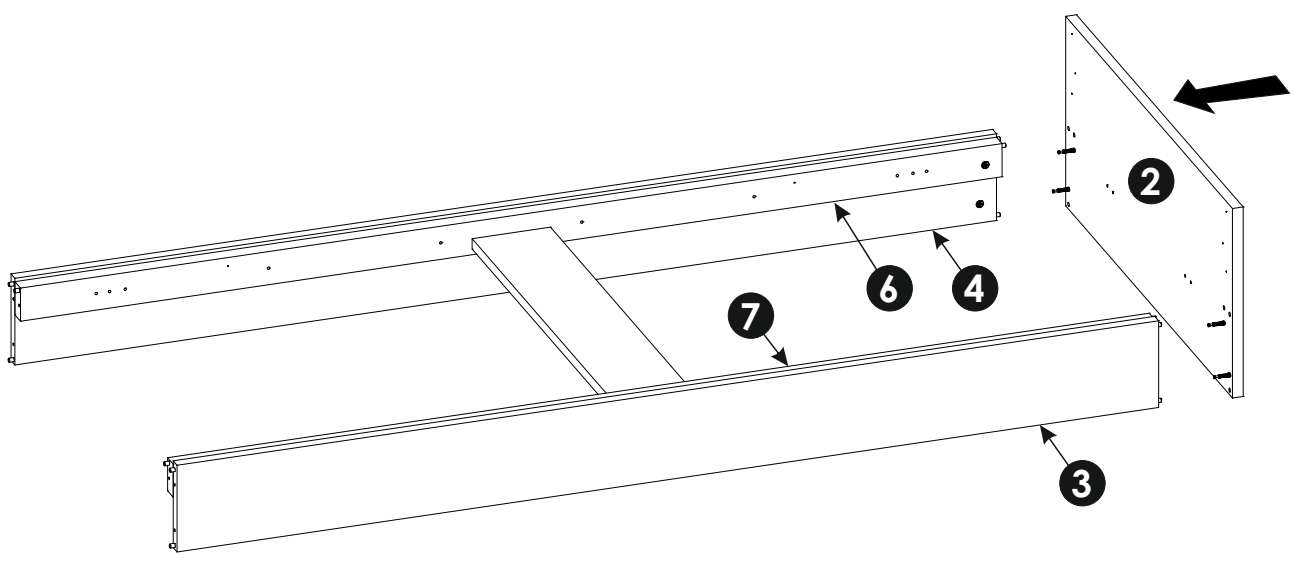
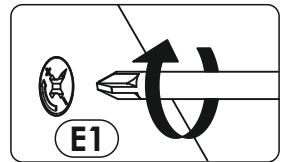
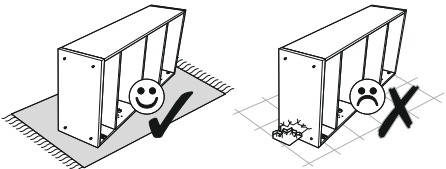

14 ▶

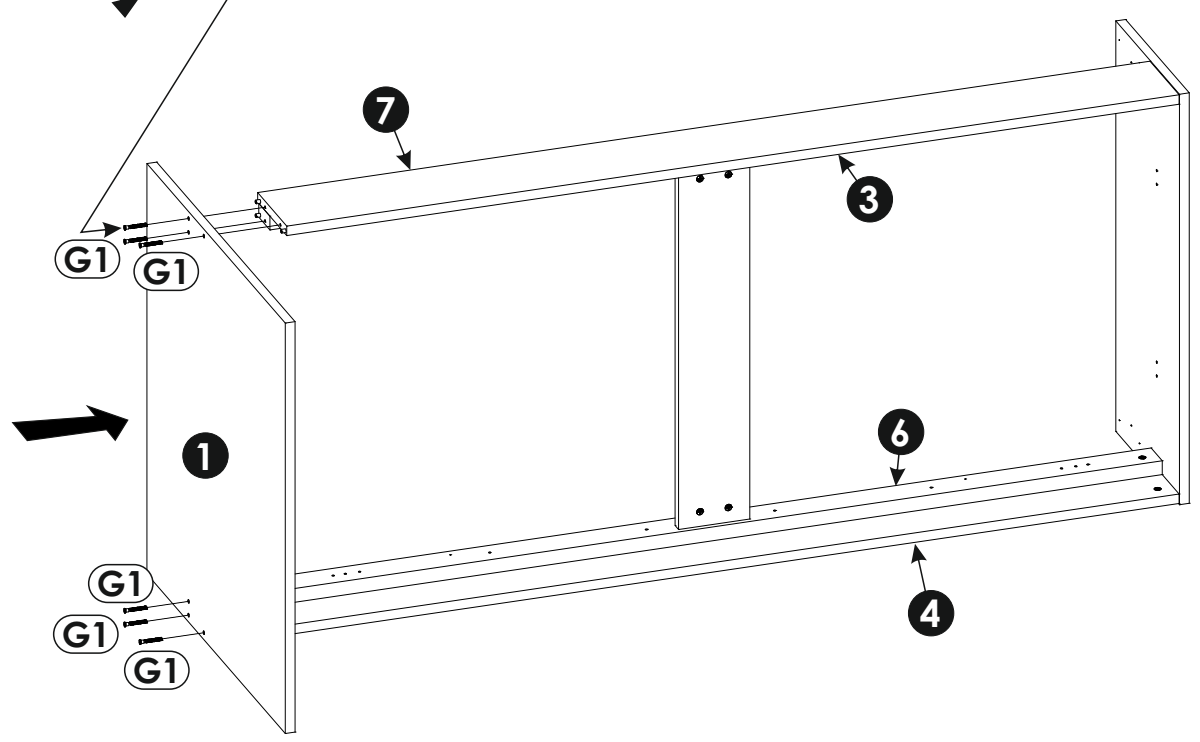
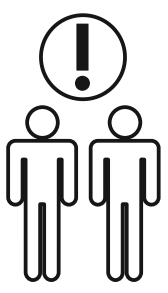
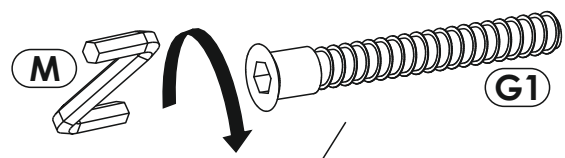
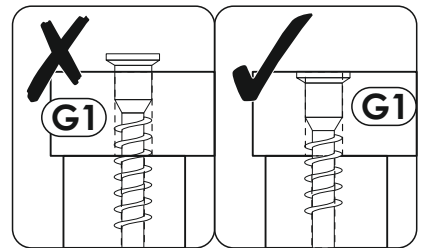
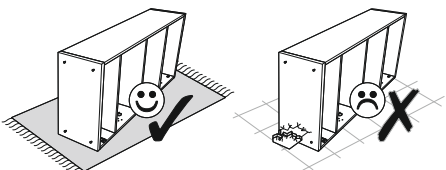

15 ▶

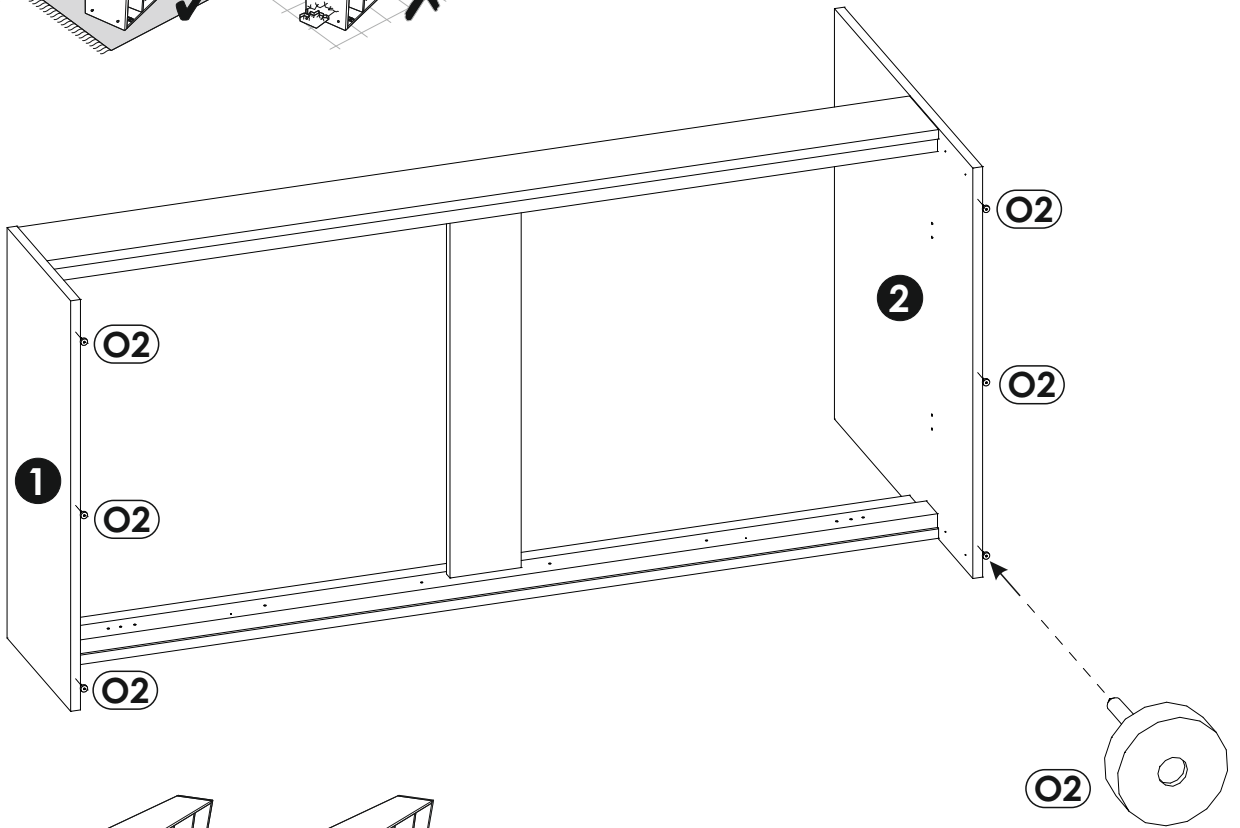
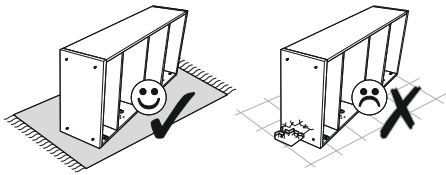

16 ▶

